



KIDS'  
BEDROOM



TRANSFORMABLE  
SYSTEMS



SERVICES



STORAGE UNITS

KIDS'  
BEDROOM

TRANSFORMABLE  
SYSTEMS

SERVICES

STORAGE UNITS



servizi, soluzioni e idee  
services, solutions and ideas  
services, solutions et idées



11

la camera dei ragazzi  
kids' bedroom  
chambre d'enfants



19

i trasformabili  
transformable systems  
systèmes transformables



45

i contenitori  
storage units  
caissons



101

## Chi siamo? Dal 1958 realizziamo arredi

Da più di **50 anni Erba è presente nel mercato dell'arredo** ed è riconosciuta come uno dei punti di riferimento nella produzione di camere per ragazzi. Importanti investimenti produttivi hanno portato ad una **crescita costante** ed hanno reso possibile l'ampliamento della gamma prodotti che si presenta attualmente come un vero sistema di arredo. Oltre al know-how riconosciute per la gestione di una produzione estremamente flessibile, l'azienda si impegna in modo continuo in **attività di ricerca nel campo dei materiali e della componentistica**. L'unità produttiva e lo showroom sorgono nel Distretto della Brianza, territorio noto per l'eccellenza produttiva nel settore arredo di fascia medio-alta e per le forti competenze tecniche e potenziale creativo.

I prodotti Erba sono **distribuiti esclusivamente attraverso una rete di rivenditori autorizzati** in grado di offrire un servizio di progettazione ed assistenza post-vendita di alto livello.



## Cosa facciamo? Prodotti e servizi

Sistemi di **arredo integrati e servizi a 360°**: sono le basi su cui si fondano ricerca e crescita. Per Erba entrambe le voci hanno la stessa importanza nel compiere quella che considera una missione: **soddisfare le esigenze** di chi sceglie i suoi prodotti.



### I servizi

Tutte le possibilità di personalizzazione, la capacità di risoluzione dei problemi, la velocità e la consulenza progettuale fornita da un efficiente ufficio tecnico, sono gli aspetti che più ci distinguono. Sistemi di arredo e servizi per noi sono le due facce di una sola realtà e sono da considerarsi parti integranti di un unico progetto: un alfabeto per comporre con creatività e sicurezza il proprio habitat ideale.

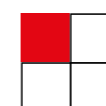

### La camera dei ragazzi

La camera dei ragazzi è il nostro "core business": un programma completo e ricco di soluzioni innovative, un progetto concreto e raffinato. Un nuovo standard per ridefinire lo spazio dei giovani di ogni età, che va oltre la comune definizione di "cameretta".

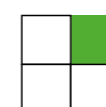

### I trasformabili

I trasformabili propongono soluzioni dinamiche per arredare spazi ridotti. Sono nati da un progetto originale ed esclusivo, sviluppato in collaborazione con l'Architetto Giulio Manzoni con un preciso obiettivo: la massima sicurezza e semplicità di funzionamento senza rinunciare al comfort e al design.

Lo spazio domestico, grazie ai programmi IQ, TOMMI e JERRI, JOY, 1x2 ISOLA e ALL IN ONE, acquista una doppia vita. Studiare, lavorare e riposare in un solo ambiente è possibile grazie alla tecnologia e varietà dei sistemi.



### I contenitori

Forme essenziali e funzionali, materiali e componenti aggiornati ai migliori standard attuali, diverse aperture in vari formati. "Contenitori" non significa solo armadi ma indica un vero e proprio sistema di moduli da utilizzare in ufficio, zona notte, living, ingresso, ripostiglio, stileria, bagno, spazi commerciali... arricchito da un prezioso servizio di progettazione e consulenza.

## Who are we? We've been creating furnishings since 1958

For more than **50 years, Erba has been present in the furnishing industry**, and today is recognized as a point of reference in the production of kids' bedrooms. Noteworthy investments in production have helped push our **constant growth**, allowing us to offer an increasingly vast array of products that are now offered as a real furnishing system. In addition to company expertise and knowhow based on an extremely flexible production, the company is now dedicated to cutting-edge **research work in the field of materials and components**. The production centre and showroom are located in Brianza, an area famous for high-end excellent furnishing production, expert workmanship, technical skills, and great creativity.

Erba products are **distributed exclusively through a network of authorized dealers**, who can offer the highest level of project design and after-sales services.



## What do we do? Products and services

**Complete, 360° integrated furnishings and services** – they are the foundation for research and growth.

For Erba, both of these aspects are equally important in order to complete what it considers a mission: **meet the needs** of those who choose its products.

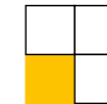

### Services

All customization and personalization, paired with problem solving, speed, and design consultancy provided by a great technical office, are aspects that set us apart from the rest.

Furnishing systems and services are the two sides of a single reality – and they should be considered integral parts of a single project: an alphabet that can be used to create, with creativity and safety, the ideal habitat.

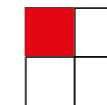

### Kids' bedroom

Kids' bedrooms are our core business: a complete programme, with a wealth of innovative solutions – a sophisticated and solid project. This is a new standard, created to redefine space for kids of any age, going well beyond the common definition of the "kids' room".

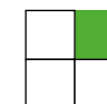

### Transformable systems

The transformable systems offer dynamic solutions for furnishing interiors with limited space. They arise from an original and exclusive project, developed in collaboration with the architect Giulio Manzoni with a precise goal in mind: maximum safety and easy use, without sacrificing comfort and design. Your abode, thanks to the IQ, TOMMI e JERRI, JOY, 1x2 ISOLA and ALL IN ONE furnishing programmes, now takes on a double life. Study, work and rest – in one interior – are now possible thanks to the system technology and diversification.



### Storage units

Essential and practical form and shapes, paired with materials and components updated to the highest current standards, offering an array of different types of opening. "Storage units" do not simply mean wardrobes, rather a real system of modules to be used in the office, bedroom, living room, hall, utility room, laundry, bathroom, commercial areas... enhanced by our cutting-edge service of design and consulting.

## Qui sommes-nous? Depuis 1958 nous réalisons des ameublements

Depuis plus de **50 ans Erba est présente sur le marché de l'ameublement** et est considérée comme une référence dans la production de chambres pour enfants. D'importants investissements dans la production ont créé une **croissance constante** et ont rendu possible l'élargissement de la gamme de produits qui se présente actuellement comme un vrai système d'ameublement. Outre son savoir-faire dans la gestion d'une production extrêmement flexible, l'entreprise développe constamment des **activités de recherche dans le secteur des matériaux et des composants**. La production et le showroom se trouvent dans la région de la Brianza, territoire connu pour ses excellents produits de gamme moyenne supérieure dans le secteur de l'ameublement et pour les grandes compétences techniques et son potentiel de créativité.

Les produits Erba sont **distribués exclusivement à travers un réseau de revendeurs autorisés** en mesure d'offrir un service lié à la conception et une assistance après-vente de haut niveau.

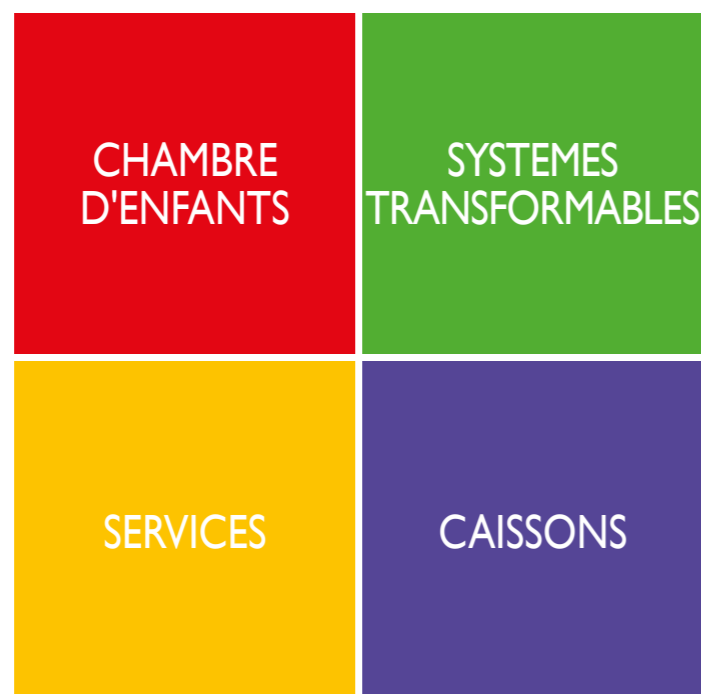

## Que faisons-nous? Produits et services

Systèmes d'**ameublement intégrés et services à 360°**: ce sont les bases sur lesquelles reposent recherche et croissance. Pour Erba les deux critères ont la même importance dans l'exécution de celle qu'elle considère une mission: **répondre aux exigences** de ceux qui choisissent ses produits.



### Services

Toutes les possibilités de personnalisation, la capacité de résolution des problèmes, la rapidité et les conseils de projet fournis par un bureau technique efficient, sont les aspects qui nous caractérisent le plus. Les systèmes d'ameublement et les services représentent pour nous les deux aspects d'une même réalité et doivent être considérés comme faisant partie intégrante d'un même projet: un alphabet pour composer avec créativité et sécurité l'habitat idéal.

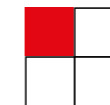

### Chambre d'enfants

La chambre d'enfants est notre "core business": un programme complet et riche de solutions innovatrices, un projet concret et raffiné. Un nouveau standard pour redéfinir l'espace des jeunes de tous âges, qui va outre la définition commune de "chambre d'enfant".

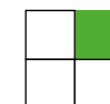

### Systèmes transformables

Les transformables proposent des solutions dynamiques pour meubler des espaces réduits. Ils sont nés à partir d'un projet original et exclusif, développé en collaboration avec l'architecte Giulio Manzoni avec un objectif précis: la plus grande sécurité et simplicité de fonctionnement sans renoncer au confort et au design.

L'espace domestique, grâce aux programmes IQ, TOMMI e JERRI, JOY, 1x2 ISOLA et ALL IN ONE, a une double vie. Il est possible d'étudier, de travailler et de se reposer dans un même espace grâce à la technologie et à la variété des systèmes.



### Caissons

Des formes essentielles et fonctionnelles, des matériaux et des composants actualisés sur les meilleurs standards actuels, différentes ouvertures en divers formats. "Caissons" ne signifie pas seulement armoires mais indique un véritable système de modules à utiliser au bureau, dans la chambre, living, entrée, débarras, buanderie, salle de bains, espaces commerciaux... enrichi par un précieux service de projet et conseil.



servizi, soluzioni e idee  
services, solutions and ideas  
services, solutions et idées







## Servizi, soluzioni e idee

Ecco alcune buone ragioni per cui potremmo essere **i vostri partner.**

### Versatilità

Tutte le nostre collezioni dialogano tra loro e si integrano dando vita ad un unico sistema di arredo. Questo significa che è possibile creare soluzioni complete spaziando dalla camera ragazzi, al mono-locale, all'ufficio in modo trasversale. Per ogni progetto la soluzione coordinata e risolutiva.

### Velocità

Il nostro sistema di produzione, tra i più innovativi, permette tempi di produzione e consegna rapidi e certi. Siamo in grado di completare il ciclo di produzione di un ordine in soli quattro giorni.

### Creatività

Le finiture non hanno vincoli di applicazione: utilizzabili indifferentemente su strutture, interni e facciate. Una tavolozza a vostra disposizione per creare volumi di colore omogeneo o stimolanti accostamenti cromatici.

### Flessibilità

Utilizziamo un nuovo e rivoluzionario sistema di produzione. Grazie a questo, tra le nostre collezioni vantiamo, ad esempio, di un sistema di contenitori interamente realizzati a misura con la possibilità di dimensioni oversize (fino a 84,2 cm di profondità e 300 cm in altezza).

### Front office

Crediamo nelle relazioni e nel dialogo. Creiamo rapporti umani. Facciamo formazione. Siamo interlocutori attivi, pre e post-vendita, a cui rivolgersi per ogni problema o necessità.

### Vivere contemporaneo

Amiamo pensare al nostro prodotto come un capo sartoriale. Nasce da qui il desiderio e l'esigenza di aggiornare continuamente la gamma finiture per essere sempre al passo con le ultime tendenze e "vestire" al meglio il nostro prodotto. "Sartorialità" significa anche "a misura", uno dei servizi che ci contraddistingue e per i quali siamo conosciuti.



## Services, solutions and ideas

Here are some good reasons why we could be **your partner**.

---

### Versatility

All of our collections communicate with each other and are completely integrated, creating a single furnishing system.

This means that you can create complete solutions ranging from the kids' bedroom, studio apartment, or office, and everything else across the board. For each project, we offer a coordinated and decisive solution.

---

### Speed

Our production line, among the most innovative available, allows for production and delivery times that are rapid and sure. We are able to complete the production cycle of an order in just four days.

---

### Creativity

Finishes have no limits regarding their application: they can be used on anything, be it on structures, interiors or fronts.

This beautiful palette is at your disposal, in order to create volumes with even colouring, or exciting chromatic pairings.

---

### Flexibility

We use a revolutionary new production system. And thanks to this, among our collections we can proudly offer, for example, a system of storage units entirely made to measure with the possibility of oversized measurements (up to 84.2 cm deep and 300 cm in height).

---

### Front office

We believe in relationships and dialogue. We create human relationships. We do training.

We are active in every discussion, before and after sales, and you can turn to us for any problem or need you might have.

---

### Contemporary living

We like to think of our product as a tailored suit. This gives rise to the desire and the need to continually update the range of finishes, in order to keep in stride with the latest trends and better "dress" our product. "Tailoring" also means "made-to-measure", one of the services that sets us apart, and for which we are well-known.

## Services, solutions et idées

Voici quelques bonnes raisons pour lesquelles nous pourrions devenir **vos partenaires**.

---

### Polyvalence

Toutes nos collections dialoguent entre elles et s'intègrent en créant un unique système d'ameublement.

Ce qui signifie qu'il est possible de créer des solutions complètes qui vont de la chambre d'enfants, au studio, au bureau en mode transversal. Pour tout projet la solution coordonnée et résolutive.

---

### Rapidité

Notre système de production, parmi les plus innovateurs, offre des délais de production et de livraison rapides et sûrs. Nous pouvons compléter le cycle de production d'une commande en quatre jours seulement.

---

### Créativité

Les finitions n'ont pas de contraintes d'application: utilisables indifféremment sur structures, intérieurs et façades. Une palette à votre disposition pour créer des volumes de couleur homogène ou des juxtapositions chromatiques stimulantes.

---

### Flexibilité

Nous utilisons un nouveau système de production révolutionnaire. Grâce à celui-ci, parmi nos collections, nous vantons, par exemple, un système de caissons entièrement réalisés sur mesure avec la possibilité d'obtenir des dimensions maxi (jusqu'à 84,2 cm de profondeur et 300 cm en hauteur).

---

### Front office

Nous croyons à l'importance des relations interpersonnelles et du dialogue. Nous créons des rapports humains. Nous faisons de la formation. Nous sommes des interlocuteurs actifs, avant et après-vente, auxquels s'adresser pour tout problème ou nécessité.

---

### Vivre dans le présent

Nous aimons penser que notre produit est le résultat du travail d'un atelier de couture. C'est ici que naît le désir et l'exigence d'actualiser constamment la gamme de finitions afin de rester à la pointe des dernières tendances et d'"habiller" au mieux notre produit. "Haute couture" signifie également "sur mesure", un des services qui nous caractérise et pour lesquels nous sommes connus.

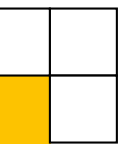



la camera dei ragazzi  
kids' bedroom  
chambre d'enfants

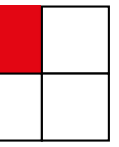

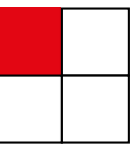

■ I contenitori della collezione *MULTIBOX* diventano supporto per lo scrittoio. Una proposta progettuale estremamente flessibile in quanto consente, grazie a questa sovrapposizione tra piano e contenitori, di adattare la soluzione ai propri spazi tramite l'utilizzo di moduli standard.

The storage units of the *MULTIBOX* collection also turn into support for the desk. This is an extremely flexible project, allowing you, thanks to this overlap between tops and storage units, to adapt the solution to your interior through the use of standard modules.

Les caissons de la collection *MULTIBOX* deviennent un support pour le bureau. Une proposition de projet extrêmement polyvalente, car elle permet, grâce à sa superposition entre plan et caissons, d'adapter la solution aux propres espaces en utilisant des modules standard.



■ Letti e scrittoi non sono semplici complementi, ma parte di un esteso sistema. Tra le varie tipologie di letto le immagini propongono il letto con la fascia apribile. In alternativa ai cassetti il letto offre la possibilità di inserire un secondo letto, come mostrano le immagini accanto.

Beds and desks are not simple accessories, but rather part of an extensive system. Among the various types of beds, these pictures highlight the bed with the frame that can be opened. As an alternative to the drawers, the bed offers the possibility to insert a second bed, as shown here.

Lits et bureaux ne sont pas de simples compléments, mais une partie d'un vaste système. Parmi les différentes typologies de lit, les images ci-contre illustrent le lit avec bande ouvrante. En alternative aux tiroirs le lit offre la possibilité d'insérer un second lit, comme le montrent les images ci-contre.

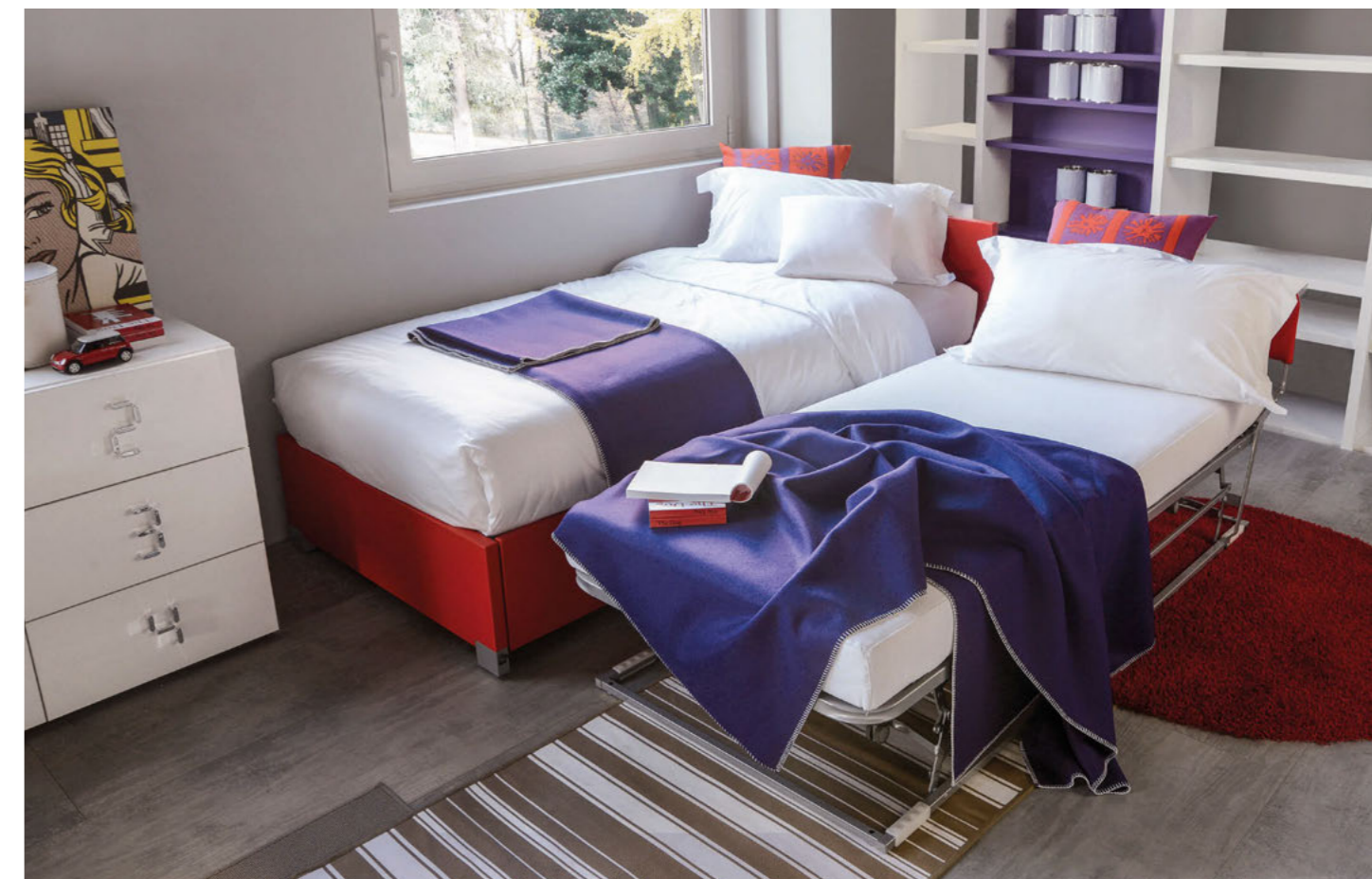

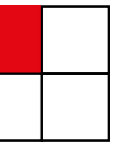

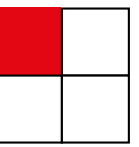

■ Il ponte con *MULTIBOX* si sostiene su elementi portanti che consentono di evitare le spalle laterali. Un'idea che apre un mondo di nuove opportunità progettuali consentendo giochi di profondità e altezze e nessun limite nella lunghezza della composizione.

The bridge-structure with *MULTIBOX* supports itself on the load-bearing units that allow you to avoid the sides. This great idea opens up a world of new project opportunities that create plays on depths and heights, without any limits on the width of the layout and composition.

Le pont avec *MULTIBOX* repose sur des éléments portants qui permettent d'éviter l'utilisation de panneaux verticaux latéraux. Une idée qui ouvre un monde de nouvelles opportunités de projet en permettant de jouer sur profondeurs et hauteurs et aucune limite dans la longueur de la composition.



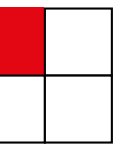



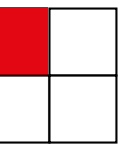

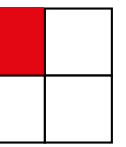

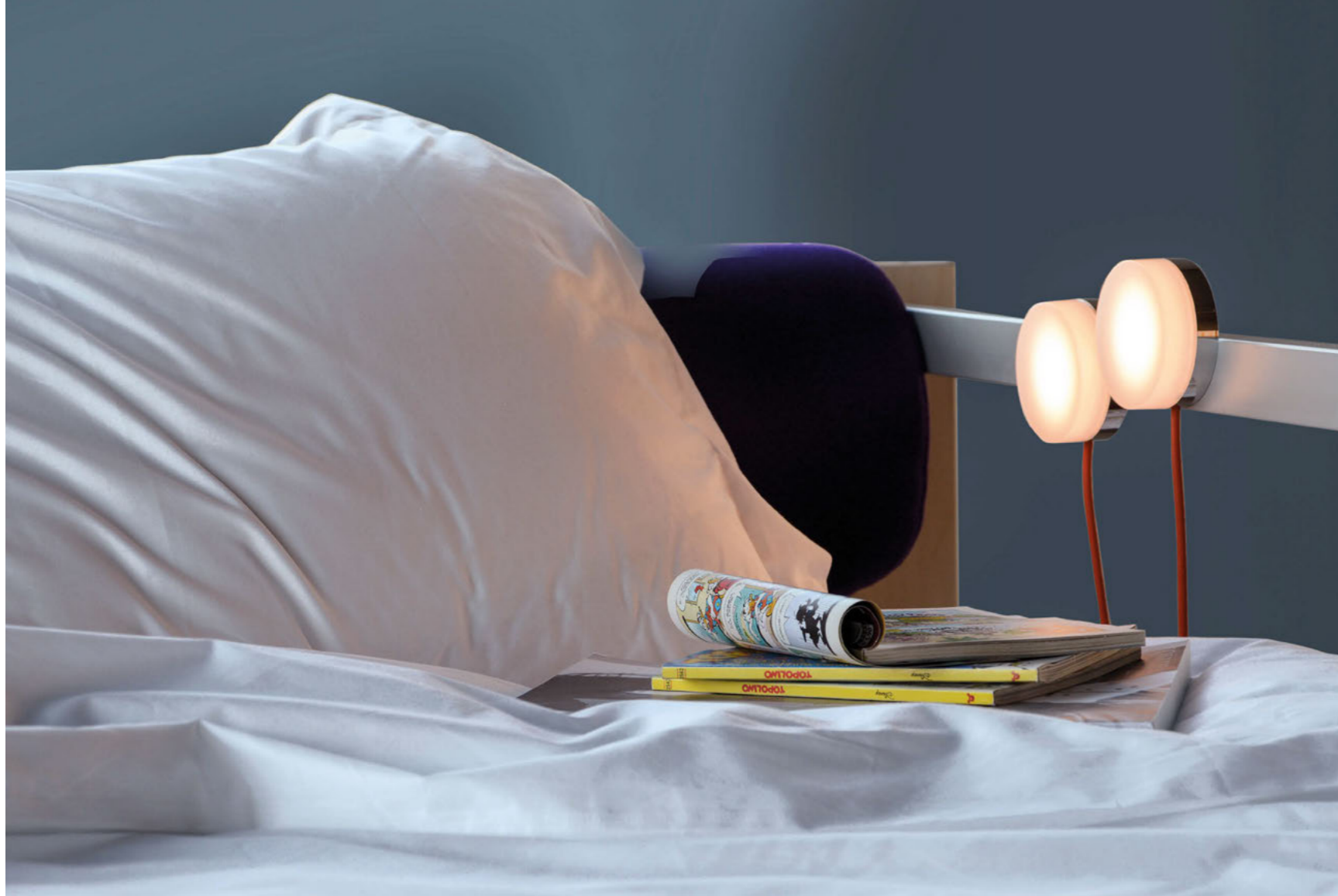
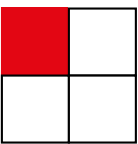

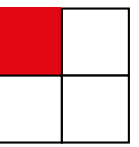

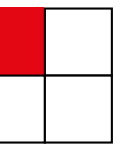

■ I letti a sbalzo sono una delle innumerevoli soluzioni del sistema letti. In questo caso la sovrapposizione sfalsata dà la possibilità di sfruttare al meglio lo spazio, aggiungendo un utile contenitore da 90 cm di profondità.

The cantilever beds are just one of the countless bed solutions. In this case, the offset overlapping helps you gain even more space, adding a useful storage unit with a depth of 90 cm.

Les lits en saillie sont une des innombrables solutions du système lits. Dans ce cas la superposition décalée offre la possibilité d'utiliser au mieux l'espace, en ajoutant une armoire de 90 cm de profondeur.

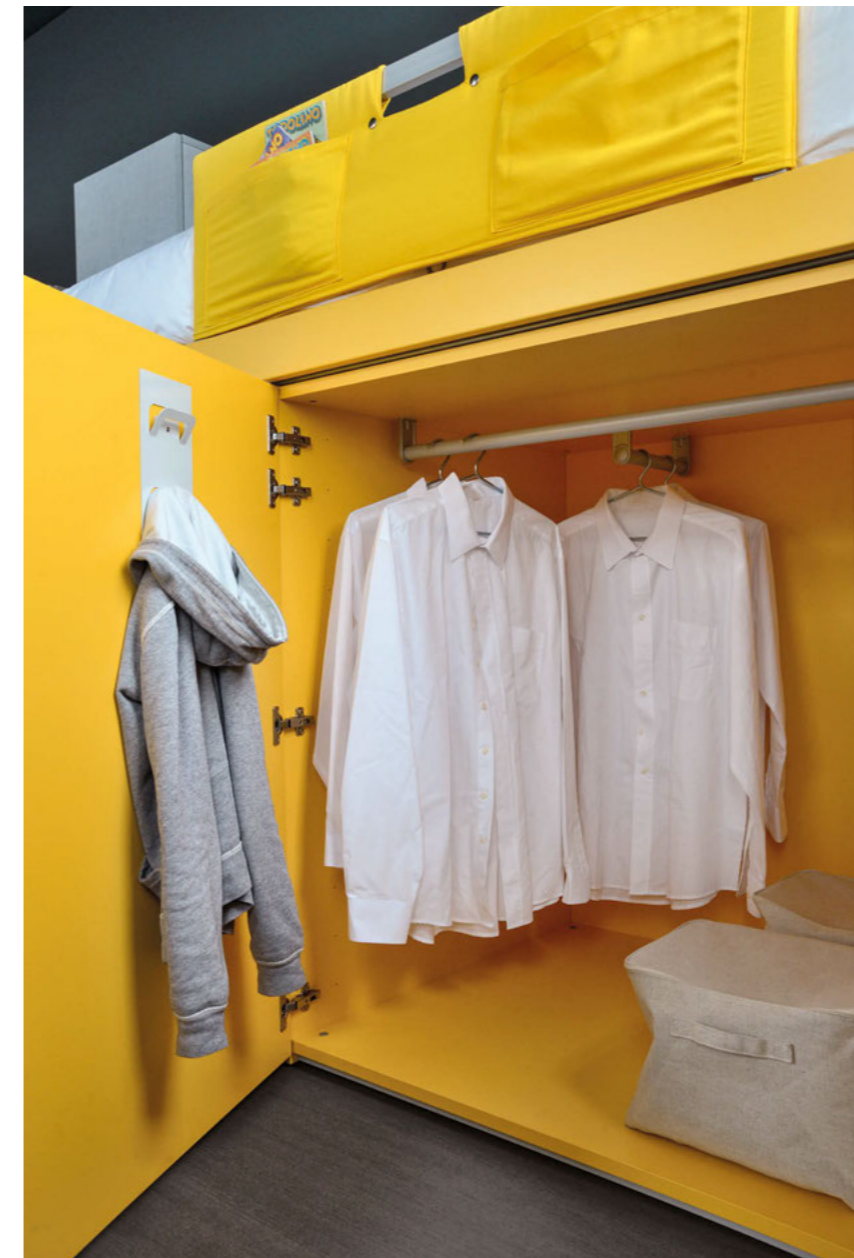

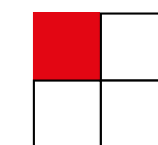

■ I letti a castello sono un vasto argomento del "Sistema letti": le combinazioni e le personalizzazioni possibili sono innumerevoli. Nell'immagine la versione del letto 1x2 da 126 cm. Disponibile anche con ruote ed in 4 larghezze: 86, 96, 106, 126 cm.

The bunk beds cover a vast array of "Bed System": the number of combinations and customizations are countless. The picture highlights the version of the bed 1x2, 126 cm wide. It also comes with wheels and in 4 widths: 86, 96, 106, 126 cm.

Les lits superposés représentent une grande partie du "Système lits": les combinaisons et les personnalisations possibles sont innombrables. Dans l'image la version du lit 1x2 de 126 cm. Disponible également avec roulettes et en 4 largeurs: 86, 96, 106, 126 cm.

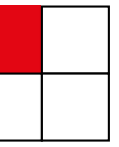



i trasformabili  
transformable systems  
systèmes transformables







■ *Tommi e Jerri* è la risposta concreta all'esigenza di maggiore spazio. È costituito da sei componenti che possono essere assemblati con estrema facilità ed è dotato del più innovativo sistema di apertura presente sul mercato. Grazie ad un semplice tocco i letti ruotano, indipendentemente l'uno dall'altro, in posizione orizzontale.

*Tommi e Jerri* is the solid answer to your needs for more space. It is made up of six easy-to-assemble components and it is equipped with the most innovative opening system found on the market. With just a simple touch, the two beds smoothly rotate independently into the horizontal position.

*Tommi e Jerri* représente la réponse concrète à l'exigence d'espace. Il est constitué de six composants qui peuvent être assemblés avec une extrême facilité. Les lits sont dotés du système d'ouverture le plus innovateur actuellement sur le marché. Grâce à un léger mouvement de la main, les deux lits, tournent indépendamment en position horizontale.

- Letto a castello
- Letto con scrittoio
- Letto inferiore
- Letto superiore

- Bunk beds
- Bed with writing desk
- Lower bed
- Upper bed

- Lits superposés
- Lit avec bureau
- Lit bas
- Lit haut





Letto inferiore  
Lower bed  
Lit bas

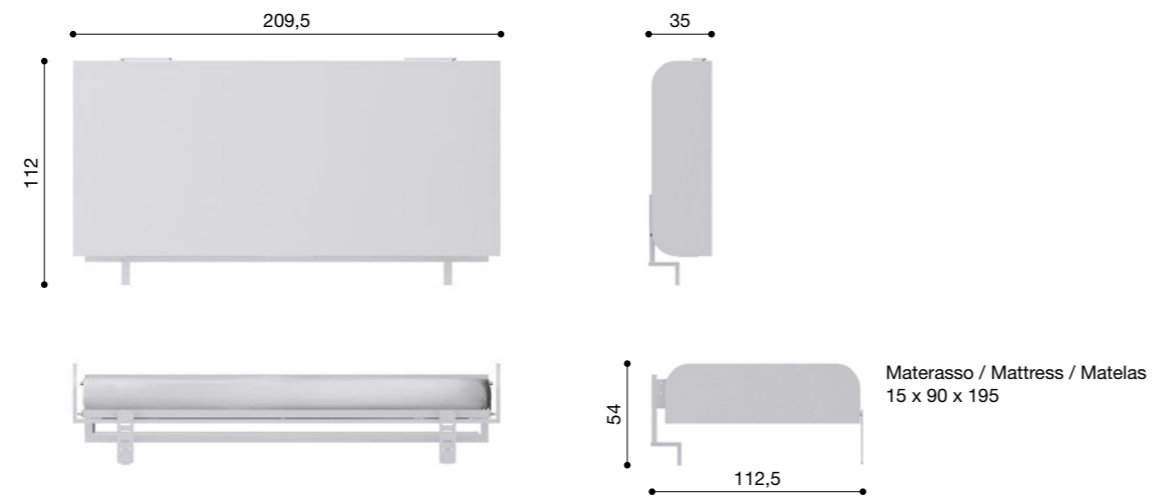

Letto a castello  
Bunk beds  
Lits superposés

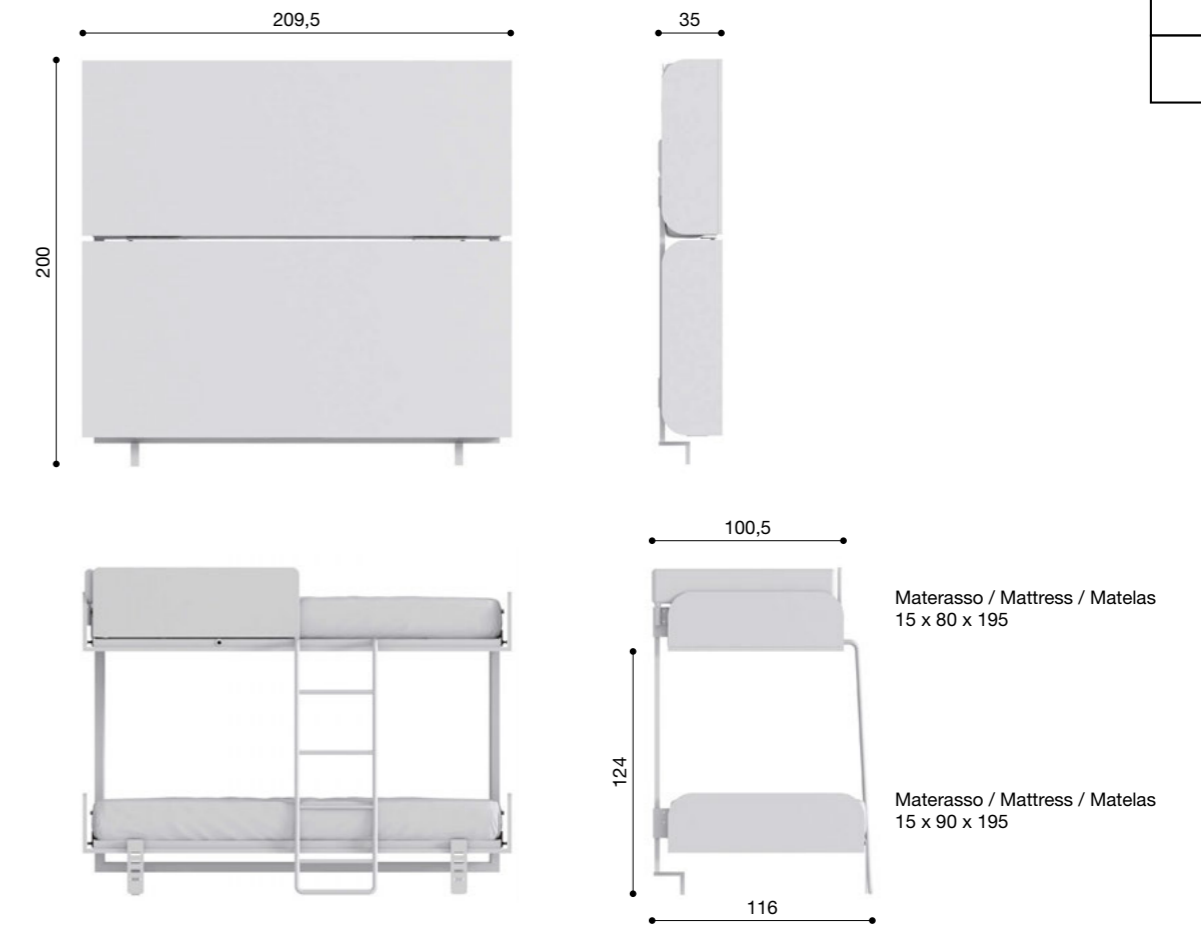

Letto superiore  
Upper bed  
Lit haut

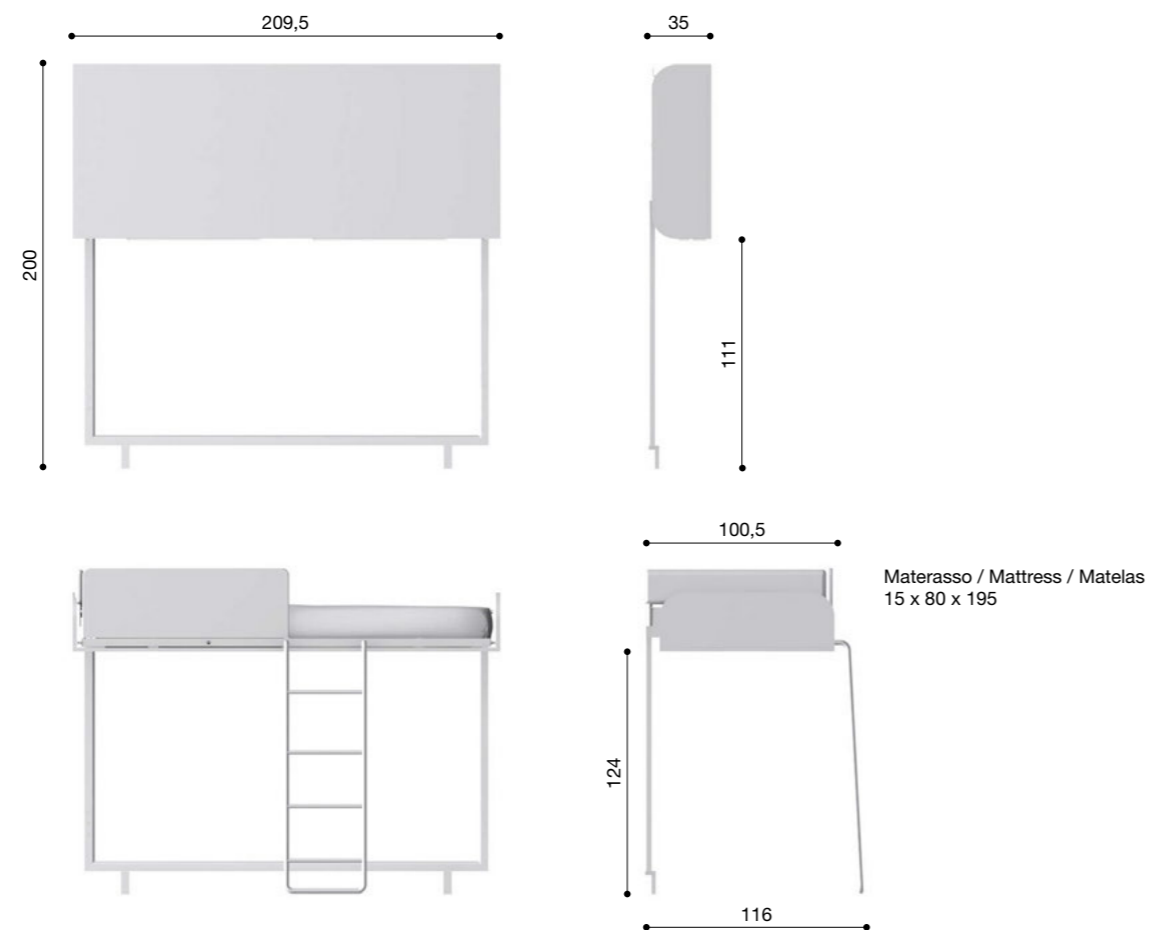

Letto con scrittoio  
Bed with writing desk  
Lit avec bureau

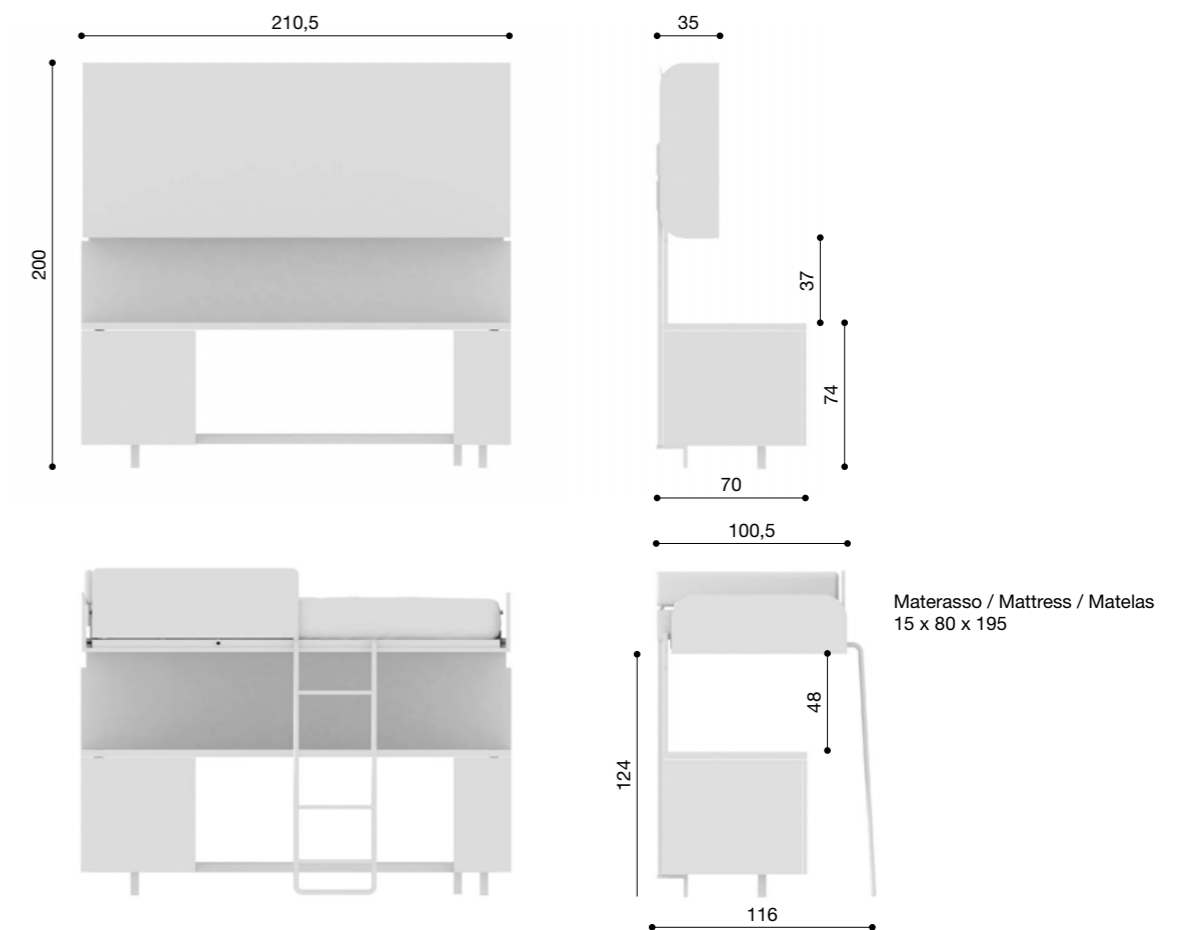





■ **Letto con scrittoio.** *TOMMI E JERRI* con scrittoio è un progetto intelligente che consente l'integrazione al letto superiore di un ampio scrittoio accessorato con due contenitori laterali. Una vera e propria isola dove studiare, lavorare e dormire. Durante il giorno il letto si chiude con un ingombro di soli 35 cm ed è possibile usufruire dello scrittoio. L'utilizzo del letto non richiede lo spostamento di nessuno degli oggetti posti sul piano di lavoro.

**Bed with writing desk.** *TOMMI E JERRI* with writing desk is an intelligent project that allows you to add, to the upper bed, a large desk equipped with two side storage units. This is a tried and true island of study, work, and rest. During the day, the bed closes up, with an overall dimension of 35 cm, and the desk can also be used. When you want to open the bed, you don't need to even move anything from the work area.

**Lit avec bureau.** *TOMMI E JERRI* avec bureau est un projet intelligent qui permet d'équiper le lit supérieur d'un grand bureau doté de deux éléments de rangement latéraux. Un véritable îlot où étudier, travailler et dormir. Pendant la journée le lit se ferme et n'occupe que 35 cm et il est possible d'utiliser le bureau. L'utilisation du lit ne requiert le déplacement d'aucun objet placé sur le plan de travail.





■ **Letto superiore.** Il letto superiore rappresenta un'eccellente alternativa al letto a castello tradizionale che prevede una struttura fissa. Grazie alla sua costruzione, completamente priva di struttura perimetrale e di conseguenza del relativo ingombro, consente di sfruttare pienamente lo spazio sottostante con l'inserimento di un'area dedicata allo studio e al relax.

**Upper bed.** The upper bed is an excellent alternative to those traditional bunk beds with fixed frames. Thanks to this construction design, which leaves out the usual perimeter frame and the space that this would take up, this bed allows you to take advantage of the underlying space for an area dedicated to study or relax.

**Lit haut.** Le lit haut représente une excellente alternative aux lits superposés traditionnels qui prévoient toujours une structure fixe. Grâce à sa construction, sans aucune structure sur le périmètre et par conséquent sans aucun encombrement, il permet d'aménager complètement l'espace situé en-dessous en réalisant une zone bureau et de détente.





■ **Letto inferiore.** Difficile definirlo "letto abbattibile". *TOMMI E JERRI* nella sua versione letto singolo inferiore è stato pensato e progettato per offrire un livello di comfort pari ad un tradizionale letto. Non si tratta di una soluzione di ripiego ma semplicemente di un letto innovativo che ha come plus la possibilità di ridurre all'occorrenza il suo ingombro in soli 35 cm offrendo inoltre ampie opportunità nella progettazione.

**Lower bed.** It really can't be simply called a "hideaway bed". The lower single bed of the *TOMMI E JERRI* system is designed to offer as much comfort as a traditional bed. It is not back-up solution – this is pure innovation. When you need to, the bed can be closed, taking up just 35 cm in depth, offering a vast array of possibilities to your project.

**Lit bas.** Il est difficile de le définir "lit rabattable". Le lit individuel bas du système *TOMMI E JERRI* a été pensé et projeté pour offrir le même confort qu'un lit traditionnel. Il ne s'agit pas d'une solution de repli mais simplement d'un lit innovateur qui vante la possibilité de réduire son encombrement à 35 cm en offrant en outre un grand nombre d'opportunités de projet.

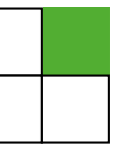



■ Grazie ad un leggero tocco, il letto, ruota in posizione orizzontale tramite un movimento dolce e costante. L'apertura non necessita di essere assistita e si arresta facilmente in caso di presenza di un qualsiasi ostacolo.

With just a simple touch, the bed smoothly rotates into the horizontal position. Opening does not require any assistance and it can be quickly and easily blocked if there are any obstacles present.

Grâce à un léger mouvement de la main, le lit, tourne en position horizontale en un mouvement lent et constant. L'ouverture ne nécessite aucune assistance et s'arrête facilement en cas de présence d'un quelconque obstacle.

- IQ128
- IQ164
- IQ218





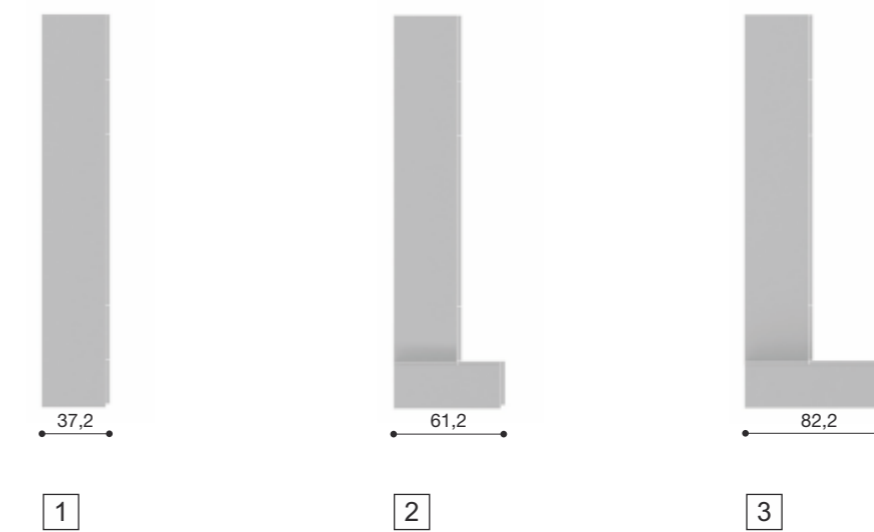
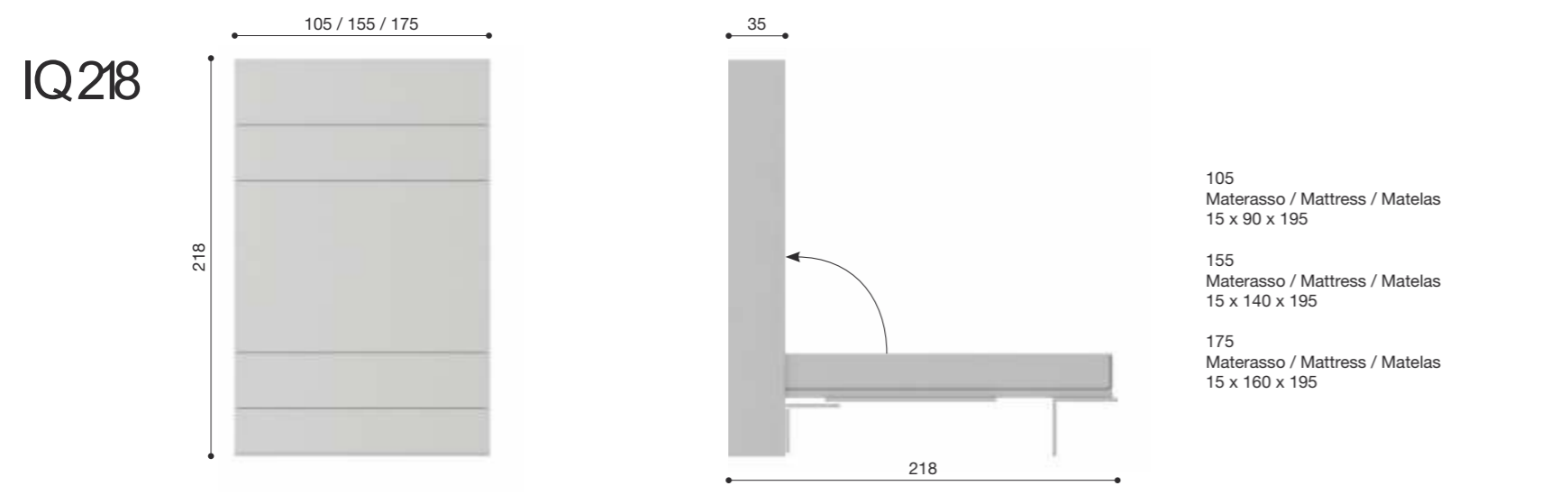
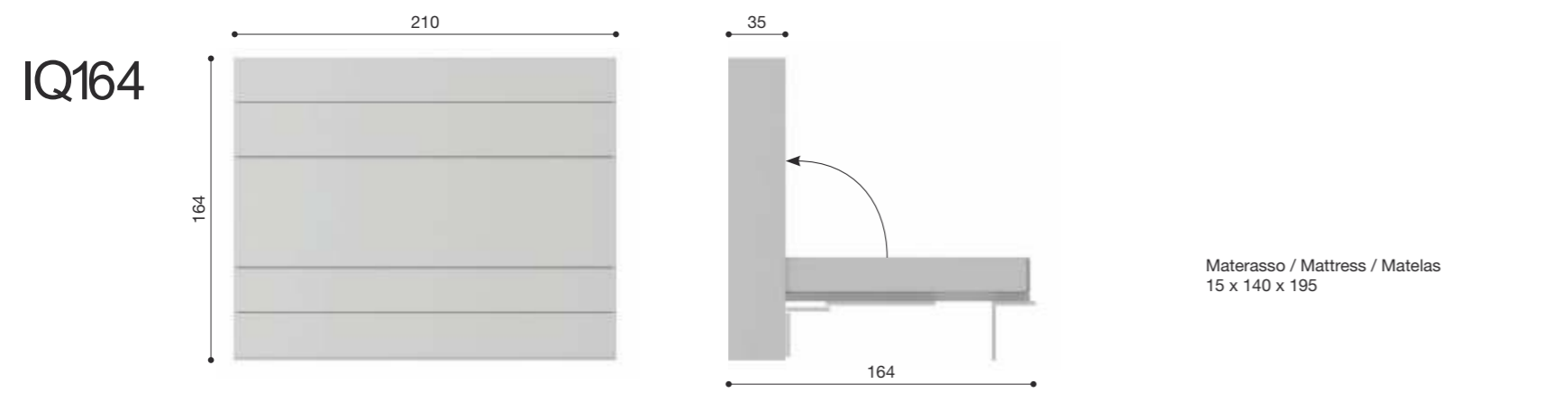
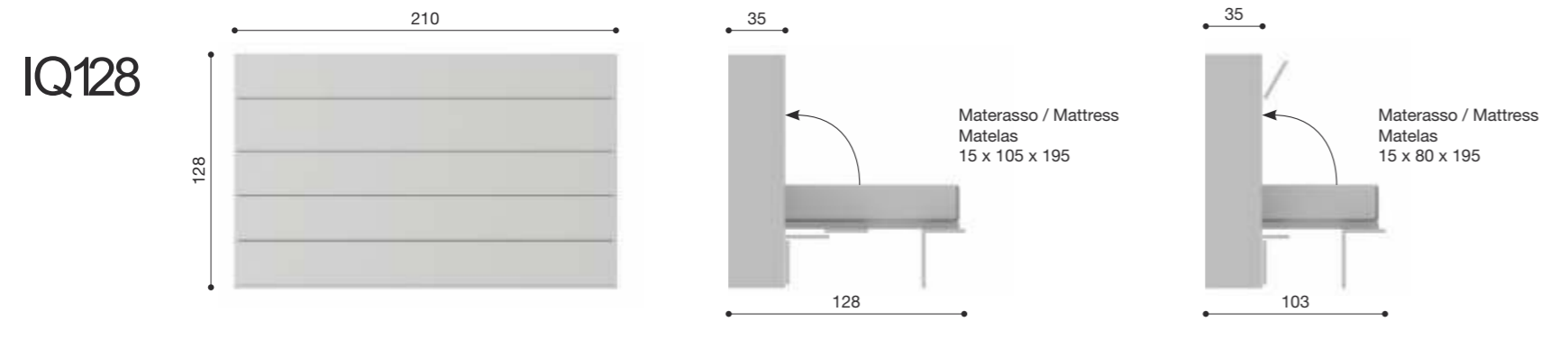
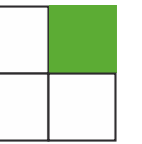

- 1
- Un concentrato di comfort, tecnologia e design in un modulo di soli 37,2 cm di profondità.
  - Pure comfort, technology and design – in a module of only 37.2 cm in depth.
  - Un concentré de confort, technologie et design dans un module de 37,2 cm de profondeur seulement.
- 2
- **Con pedana prof. 61,2 cm.** La misura perfetta per sfruttare al massimo le potenzialità del sistema Erba. Nelle nostre collezioni sono disponibili un'ampia varietà di contenitori della profondità di 61,2 cm da affiancare al vostro IQ con pedana. Funzionalità e design per una volta insieme in soluzioni uniche.
  - **With low bench, depth of 61.2 cm.** The perfect measurement to take advantage of the Erba system's potential. Our collections also offer a wide variety of storage units with a depth of 61.2 cm, to be paired up with your IQ that includes the low bench. Practicality and design finally come together in a single solution.
  - **Avec estrade prof. 61,2 cm.** La mesure parfaite pour exploiter au maximum les potentialités du système Erba. Dans nos collections sont disponibles une vaste gamme d'éléments de la profondeur de 61,2 cm à juxtaposer à votre IQ avec estrade. Fonctionnalité et design pour une fois ensemble dans des solutions uniques.

- 3
- **Con pedana prof. 82,2 cm.** Una pedana dalla profondità insolita ma utile che attribuisce a IQ un plus da non sottovalutare: la pedana da 82,2 cm rende IQ un letto autoportante che non richiede l'ancoraggio a muro della struttura ma soltanto un minimo fissaggio di sicurezza. Per questo si adatta perfettamente a locali con pareti in cartongesso.
  - **With low bench, depth of 82.2 cm.** A low bench with an unusual depth, but which gives IQ a special extra touch – the 82.2 cm low bench makes IQ a self-supporting bed that does not require wall-anchoring of the frame, but rather simply the minimum safety fastenings. For this reason IQ is perfect for apartments with gypsum board walls.
  - **Avec estrade prof. 82,2 cm.** Une estrade avec une profondeur insolite mais utile qui apporte à IQ un plus à ne pas sous-évaluer: l'estrade de 82,2 cm fait de l' IQ un lit autoportant dont la structure ne nécessite aucun ancrage mural mais seulement une fixation minimum de sécurité. Pour cette raison IQ est parfait pour appartements avec parois de placoplâtre.



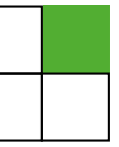







IQ218



design G. Manzoni

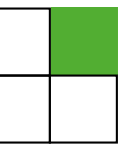

■ I letti del sistema IQ possono essere inseriti come elementi autonomi in qualsiasi contesto oppure perfettamente integrati alle altre collezioni Erba per creare soluzioni d'arredo per living, monolocali, spazi per giovani o per adulti dove occorre sopperire alla scarsità di spazio.

The IQ system beds can be added as single elements in any context, or perfectly integrated with other Erba collections, creating furnishing solutions for the living room, studio apartments, as well as interiors for the young and old, where you need to make up for lack of space.

Les lits du système IQ peuvent être insérés comme des éléments autonomes dans tout contexte ou parfaitement intégrés aux autres collections Erba pour créer des solutions d'ameublement pour living, studios, espaces pour jeunes ou pour adultes là où il faut compenser le manque d'espace.

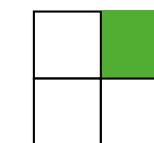

■ Il sistema *IQ* si completa con il modello *IQ SOFT*. Il letto è dotato di un divano dal design informale e moderno. Grazie ad un semplice movimento, il divano scorre frontalmente aprendo un contenitore per cuscini. Il letto si apre in modo dolce, senza bisogno di assistenza.

The *IQ* system is rounded off with the *IQ SOFT* model. The bed has a sofa with casual yet modern design. Thanks to a simple movement, the sofa opens up in the front with a box for pillows. The bed opens up smoothly, without assistance.

Le système *IQ* est complété par le modèle *IQ SOFT*. Le lit est doté d'un divan au design informel et moderne. Grâce à un simple mouvement, le divan glisse frontalement en ouvrant un caisson pour coussins. Le lit s'ouvre doucement, sans besoin d'assistance.

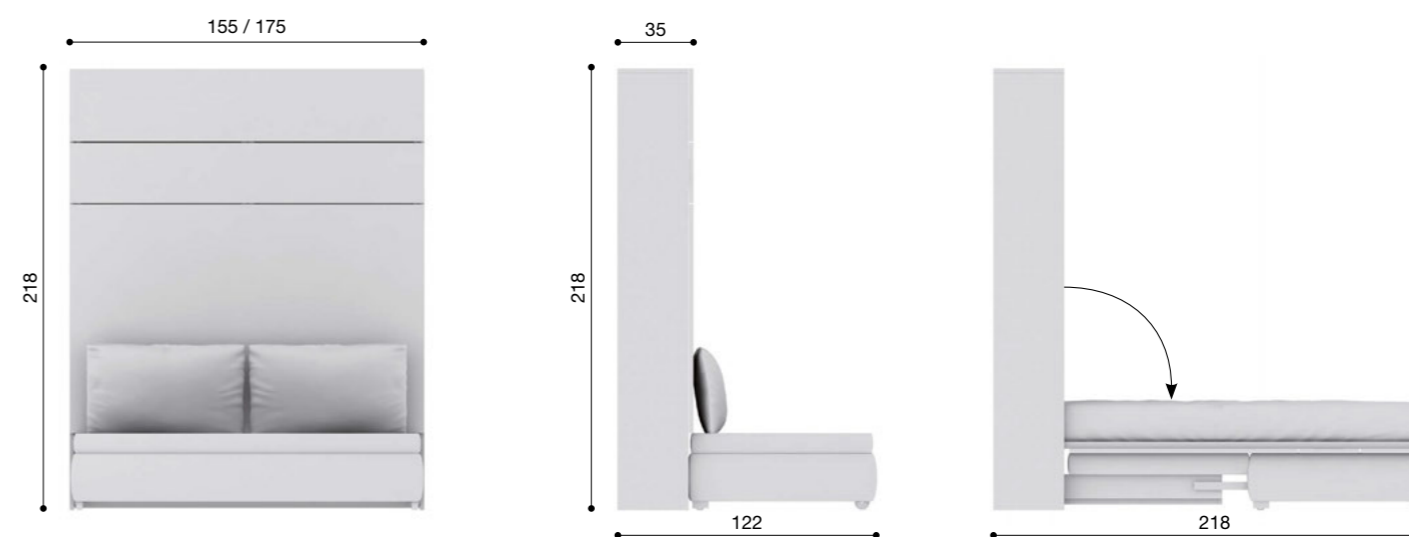

155  
 Materasso / Mattress / Matelas  
 15 x 140 x 195

175  
 Materasso / Mattress / Matelas  
 15 x 160 x 195





**IQSOFT**  
218128 128164  
design G. Manzoni

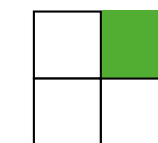



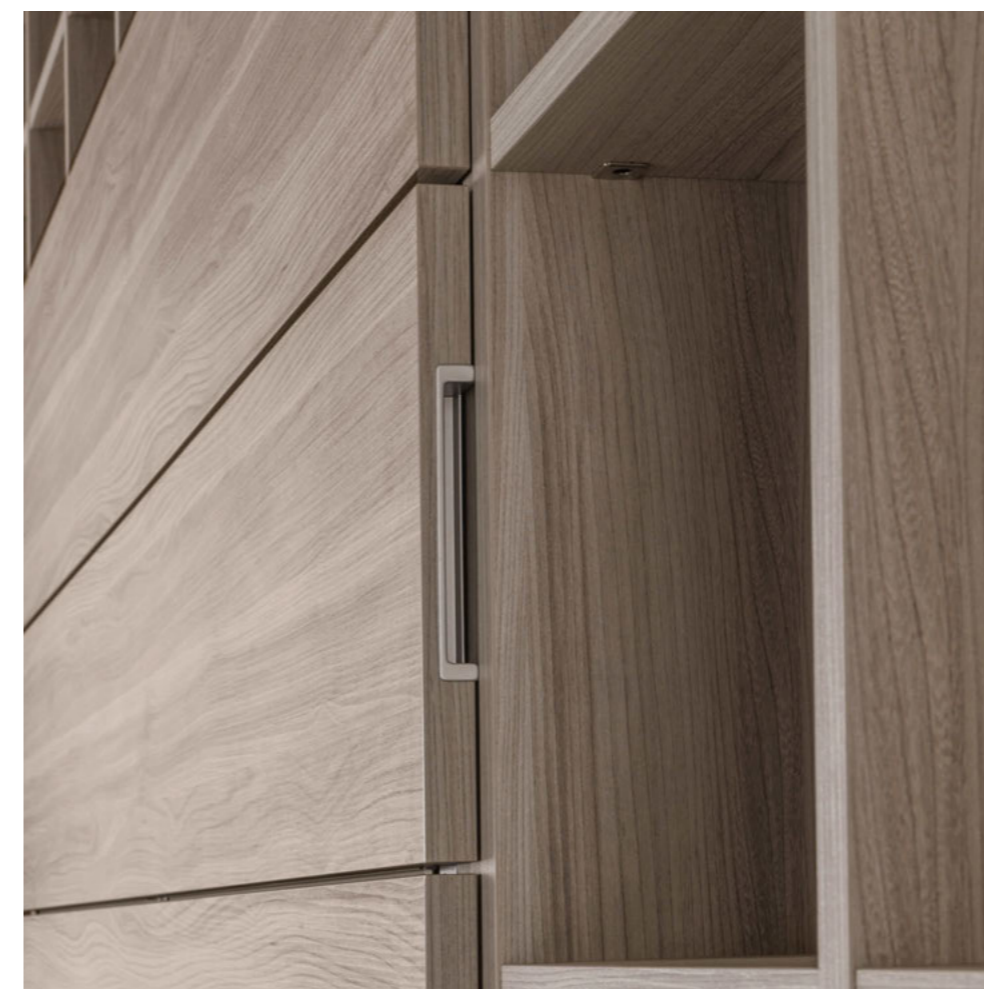
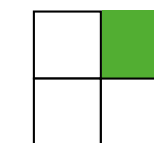

■ *IQ SOFT* è dotato di un ampio contenitore a cui si accede grazie allo scorrimento frontale del divano. Durante il giorno il contenitore può accogliere i guanciali.

*IQ SOFT* is equipped with a large storage unit that can be accessed through the sliding front part of the sofa. During the day the storage unit can accommodate pillows.

*IQ SOFT* est doté d'un grand caisson auquel on accède grâce au coulissement frontal du divan. Pendant la journée le caisson peut contenir les oreillers.

■ Il divano è dotato di due freni posizionati lateralmente per evitare ogni spostamento durante l'utilizzo.

The sofa has two brakes positioned laterally to avoid any movement during use.

Le divan est équipé de deux freins placés latéralement pour éviter tout déplacement pendant l'utilisation.

■ L'apertura del letto avviene grazie a due maniglie incassate lateralmente o frontalmente. La posizione delle maniglie viene definita in base al progetto nel quale è inserito *IQ SOFT*.

The opening of the bed is carried out via two recessed handles, found laterally or frontally. The position of the handles is defined according to the project in which *IQ SOFT* is added.

L'ouverture du lit s'effectue grâce à deux poignées encastrées latéralement ou frontalement. La position des poignées est définie en fonction du projet dans lequel est inséré *IQ SOFT*.



■ Estremamente minimal nella sua costruzione, *JOY*, è l'ultimo frutto della collaborazione con l'architetto Giulio Manzoni. A differenza dei tradizionali letti abbattibili, Joy, è privo di struttura. Questa caratteristica fa sì che, una volta aperto, somigli ad un normale letto e non ad un letto abbattibile. Joy si presenta come il prodotto *entry level* della collezione trasformabili di Erba.

With its extremely minimal build, *JOY* is the latest creation of our collaboration with the architect Giulio Manzoni. Unlike traditional hideaway beds, Joy is built without any frame. Thanks to this feature, once opened, it looks like a traditional bed, rather than a hideaway bed. Joy is the entry-level product of the hideaway collection by Erba.

Extrêmement minimaliste dans sa construction, *JOY*, est le dernier né de la collaboration avec l'architecte Giulio Manzoni. A la différence des lits rabattables traditionnels, Joy, est sans structure. Cette caractéristique fait que, une fois ouvert, il ressemble à un lit normal et non à un lit rabattable. Joy est le produit entry level de la collection de transformables d'Erba.

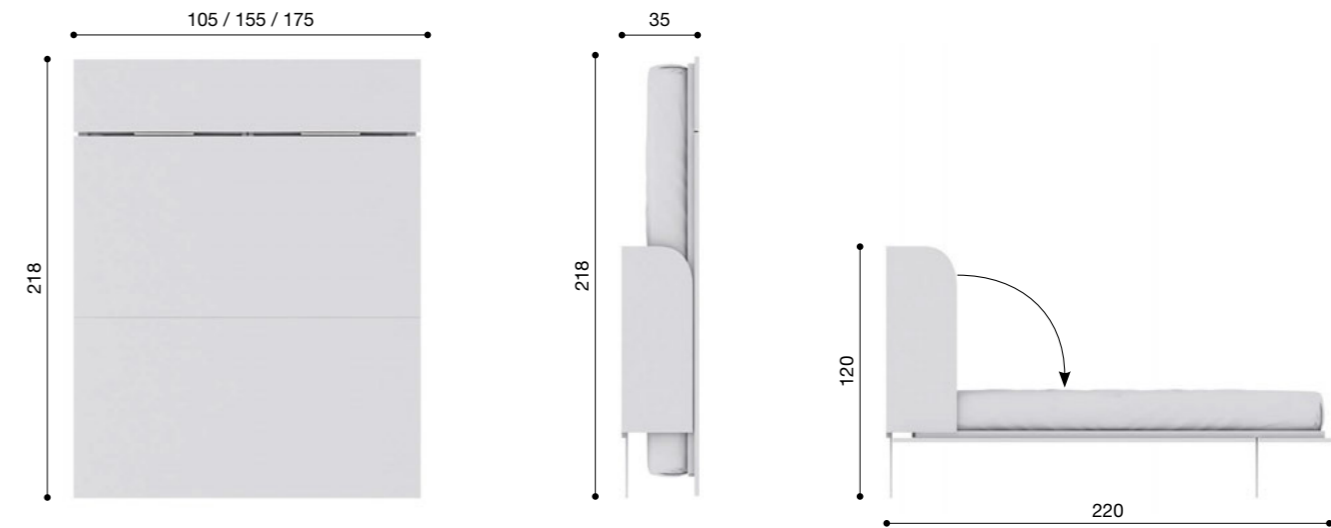

105  
Materasso / Mattress / Matelas  
15 x 90 x 195

155  
Materasso / Mattress / Matelas  
15 x 140 x 195

175  
Materasso / Mattress / Matelas  
15 x 160 x 195





■ **ALL IN ONE** è la giusta soluzione ai problemi di spazio: letto trasformabile con scrittoio integrato. Lo scrittoio si ripone in orizzontale sotto il letto, lasciando uno spazio utile di 21 cm per i vostri oggetti. Brevetto depositato.

**ALL IN ONE** is the perfect solution for limited space: a transformable bed with a writing desk. Once the bed is closed, the writing desk stays in the horizontal position, offering 21 cm of space where you can leave anything you may need. Patented product.

**ALL IN ONE** est la solution idéale pour tous les problèmes d'espace: lit transformable avec bureau. Quand le lit est fermé, le bureau reste en position horizontale en laissant un espace utile de 21 cm pour y poser des objets. Brevet déposé.



Materasso / Mattress / Matelas  
15 x 85 x 190

Scrittoio / Desk / Bureau  
60 x 184

- Un'idea che ottimizza lo spazio per la crescita • An idea that optimizes an interior as your kids grow
- Une idée qui optimise l'espace pour la croissance

**allinone**  
design G. Manzoni

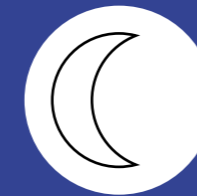

2 m<sup>2</sup>



**2 m<sup>2</sup>** ✓

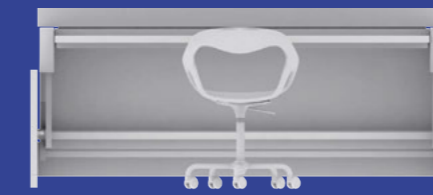

0 m<sup>2</sup>

**Traditional System**

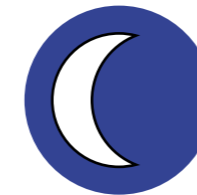

2 m<sup>2</sup>

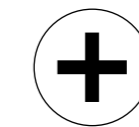

**3,10 m<sup>2</sup>**



1,10 m<sup>2</sup>



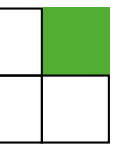



■ La fascia del letto è dotata di pistoni e può essere facilmente richiusa per agevolare l'utilizzo del piano scrittoio.

The bed frame is equipped with pistons and can be easily closed for quick use of the writing desk.

La bande du lit est équipée de pistons et peut être facilement refermée pour faciliter l'utilisation du bureau.



■ La chiusura del letto ha inizio con l'operazione di sblocco tramite una leva posizionata sotto il piano scrittoio.

The closure of the bed begins with the release action through a lever placed under the writing desk.

La fermeture du lit commence par l'action de déblocage à l'aide d'un levier placé sous le bureau.



■ Il letto possiede quattro ruote unidirezionali. Ogni ruota, realizzata in gomma antitraccia, è dotata di freno.

The bed has four unidirectional wheels. Each wheel, made of non-marking rubber, is equipped with a brake.

Le lit a quatre roulettes unidirectionnelles. Chaque roulette est réalisée en caoutchouc anti-trace et équipée d'un frein.

# 1x2 ISOLA

design G. Manzoni



■ Una vera e propria camera su ruote. Letto, armadio, libreria e scrittoio in un unico accessorio.  
Un innovativo ed originale progetto firmato dall'architetto Giulio Manzoni.

A real room on wheels. Bed, wardrobe, bookcase and desk in a single accessory.  
An innovative and original project, designed by architect Giulio Manzoni.

Une véritable chambre sur roulettes. Lit, armoire, bibliothèque et bureau en un unique accessoire.  
Un projet innovateur et original signé par l'architecte Giulio Manzoni.



Lato A - Side A - Côté A



Lato B - Side B - Côté B

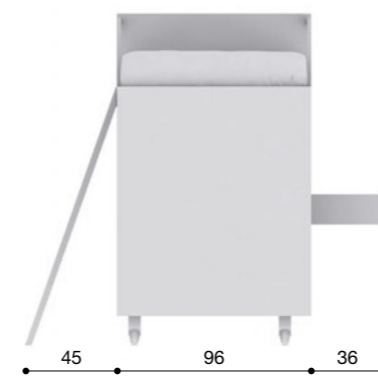

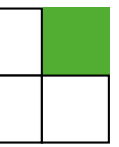





■ Il letto è dotato di quattro ruote con freno per consentire lo spostamento.

The bed is equipped with four wheels with a brake, in order to allow the easy moving.

Le lit est équipé de quatre roulettes avec frein pour permettre le déplacement.

■ Tramite un semplice movimento è possibile, all'occorrenza, estrarre un ulteriore piano scrittoio, ampliando la superficie di lavoro fino a 81 cm.

Just a simple touch and you can pull out an additional writing top and extend the working surface up to 81 cm.

A l'aide d'un simple mouvement il est possible, au besoin, d'extraire un autre plan bureau, en étendant le plan de travail jusqu'au 81 cm.

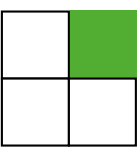

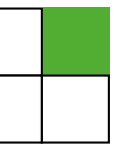



■ **MULTIDESK** si presenta come un tradizionale modulo con cassetto. Questo nuovo accessorio trasformabile è invece dotato di un meccanismo che, con un semplice gesto, permette di estrarre un ulteriore piano scrittoio e di ampliare la superficie di lavoro da 47,5 a 83,5 cm.

*MULTIDESK* looks like a traditional unit with drawer. This new product is equipped with a new mechanism that, with just a simple touch, offers the possibility to pull out an additional writing top and extend the working surface from 47.5 to 83.5 cm.

*MULTIDESK* se présente comme module traditionnel à tiroir. Ce nouvel accessoire transformable est par contre doté d'un mécanisme qui, à l'aide d'un simple geste, permet d'extraire un autre plan de travail et d'étendre la surface de travail de 47,5 à 83,5 cm.





i contenitori  
storage units  
caissons



## FREESTYLE

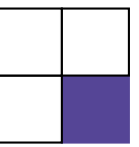

■ *FREESTYLE* è un programma a moduli che si compone accostando e sovrapponendo elementi autonomi, combinati liberamente senza vincoli di dimensione o tipologia. Il colore, in particolare, è un suo aspetto essenziale, non solo per la ricca e costantemente aggiornata tavolozza, ma soprattutto per la possibilità di usarlo su tutto il modulo e, per i più audaci, perfino la possibilità di usare colori diversi all'interno dello stesso modulo.

Volumi interamente colorati che si combinano in un gioco creativo di infinite possibilità sono un'esclusiva caratteristica di *FREESTYLE*, solo oggi resa possibile da una linea di produzione e da una gestione dei singoli progetti tecnologicamente all'avanguardia.

*FREESTYLE* is a programme of modules that is created by pairing and overlapping autonomous units, combined freely without constraints on size or type. The colour, in particular, is an essential aspect, not only for the vast and constantly updated palette, but especially because you can use it on the entire module, and, for the more daring, even the possibility of using different colours within the same module.

These beautiful volumes are entirely coloured and can be combined in a creative play on these infinite possibilities – an exclusive feature of *FREESTYLE*, only now made possible by a cutting-edge production line and management of single projects.

*FREESTYLE* est un programme à modules qui se compose en juxtaposant et en superposant des éléments autonomes, combinés librement sans contraintes de dimension ou typologie. La couleur, en particulier, est son principal aspect, non seulement pour la riche palette constamment mise à jour, mais surtout pour la possibilité d'utiliser la couleur sur tout le module et, pour les plus audacieux, il est également possible d'utiliser des couleurs différentes à l'intérieur du même module. Des volumes entièrement colorés qui sont combinés entre eux en un jeu de création aux possibilités infinies sont une caractéristique exclusive de *FREESTYLE*, devenu aujourd'hui possible grâce à une ligne de production et à une gestion de projets individuels technologiquement à l'avant-garde.

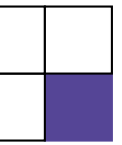

■ Maniglia M1 - M1 Handle - Poignée M1



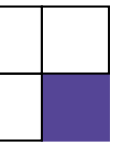

■ Maniglia M4 - M4 Handle - Poignée M4

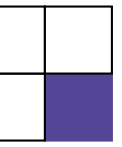



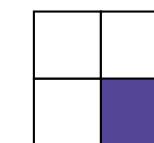

■ Pensato e progettato per essere un sistema di contenitori universale, *FREESTYLE* è in grado di risolvere molteplici situazioni poco convenzionali (angoli, mansarde, passaggi etc.). Grazie alla sua flessibilità progettuale, derivante dall'essere un sistema modulare, *FREESTYLE* trova largo utilizzo nella casa e non solo.

Created and designed to be a system of universal storage units, *FREESTYLE* can solve a number of unconventional situations (corners, attics, halls or passageways, etc.). Thanks to its design flexibility, due to the fact that it is a modular system, *FREESTYLE* can be widely used in the home and just about anywhere else.

Pensé et projeté pour être un système de caissons universel, *FREESTYLE* est en mesure de résoudre de multiples situations peu conventionnelles (angles, mansardes, passages etc.). Grâce à sa conception polyvalente, qui découle du fait qu'il s'agit d'un système modulaire, *FREESTYLE* trouve une large utilisation dans la maison et pas seulement.

# 10 MM

■ Con "10 MM" Erba presenta un nuovo tipo di contenitore che supera la comune idea di modularità e apre nuove ed inaspettate prospettive di utilizzo.

Nuove tecnologie per la produzione e la gestione del workflow permettono la realizzazione di contenitori letteralmente modellati sullo spazio esistente; questo significa che è possibile riempire, ad esempio, un vano largo 352 cm, profondo 68,4 cm, alto 242,5 cm con un contenitore delle misure esatte; senza costosi tagli su misura, tamponamenti o aggiustamenti.

Lo spazio residuo tra spalle e pareti è di 10 mm totale e 10 mm lo spazio dal soffitto; una tale precisione nella fase di montaggio è resa possibile dal nuovo tipo di ferramenta appositamente progettata.

Con queste caratteristiche, "10 MM" si propone come contenitore universale, con la possibilità di dimensioni "oversize" (84,2 cm in profondità, 300 cm in altezza), nato per arredare e dare ordine alle cose in ogni spazio abitato: UFFICIO, ZONA NOTTE, CUCINA, SOGGIORNO, INGRESSO, RIPOSTIGLIO, STIRERIA, BAGNO, SPAZIO COMMERCIALE...

With "10 MM", Erba offers a new way of storing that goes beyond the common idea of modularity, pioneering new and unexpected uses.

New technologies for production and workflow management now allow for the creation of storage units that are literally modelled around your existing interior – this means you can add a storage unit to a space that is exactly 352 cm wide, 64.8 cm deep, and 242.5 cm in height, just to give you an example – without expensive custom cuts, cover panelling or filling strips.

The residual space between the sides and walls totals just 10 mm, along with the 10 mm of the ceiling – such a precise installation is made possible thanks to a new type of specifically designed hardware.

With these features, "10 MM" is now offered as a universal storage, including the "oversize" model (84.2 cm in depth, 300 cm in height), designed to furnish and give order to any interior in your place: OFFICES, BEDROOMS, KITCHENS, LIVING ROOMS, ENTRANCE HALLS, STORAGE CLOSETS, WASHROOMS, SALES POINTS, anywhere and everywhere...

Avec "10 MM" Erba présente un nouveau type de caisson qui dépasse l'idée commune de modularité et offre de nouvelles perspectives d'utilisation inattendues.

De nouvelles technologies pour la production et la gestion du workflow permettent la réalisation de caissons littéralement modélés sur l'espace existant; ce qui signifie qu'il est possible de remplir, par exemple, un compartiment d'une largeur de 352 cm, profondeur 68,4 cm, hauteur 242,5 cm avec un caisson de ces mêmes dimensions; sans découpes sur mesure, fileurs ni ajustements coûteux.

L'espace résidu entre panneaux verticaux et parois est de 10 mm au total et 10 mm l'espace du plafond; une telle précision dans la phase de montage est rendue possible grâce au niveau type de quincaillerie spécialement projetée.

Avec ces caractéristiques, "10 MM" est proposé comme caisson universel, avec la possibilité d'avoir des dimensions "oversize" (84,2 cm de profondeur, 300 cm de hauteur), né pour meubler et ranger des objets présents dans tout espace de vie : BUREAU, ZONE NUIT, CUISINE, SEJOUR, ENTREE, DEBARRAS, ZONE REPASSAGE, SALLE DE BAINS, ESPACE COMMERCIAL...

## i plus di 10 MM



**1** NESSUNA FASCIA DI CHIUSURA  
NO CLOSURE STRIPS  
AUCUNE BANDE DE FERMETURE

**2** NESSUN TAGLIO A MISURA  
NO EXPENSIVE CUSTOM CUTS  
AUCUNE DECOUPE SUR MESURE

**3** NESSUN SOVRAPPREZZO  
NO EXTRA COSTS  
AUCUNE MAJORATION DE PRIX

**4** PROFONDITÀ DA 20 A 84,2 cm  
DEPTH: FROM 20 TO 84.2 cm  
PROFONDEUR: DE 20 A 84,2 cm

**5** ALTEZZA: FINO A 300 cm  
HEIGHT: UP TO 300 cm  
HAUTEUR: JUSQU'AU 300 cm

**6** SOLO 10 mm PER IL MONTAGGIO  
JUST 10 mm FOR THE INSTALLATION  
SEULEMENT 10 mm POUR L'INSTALLATION



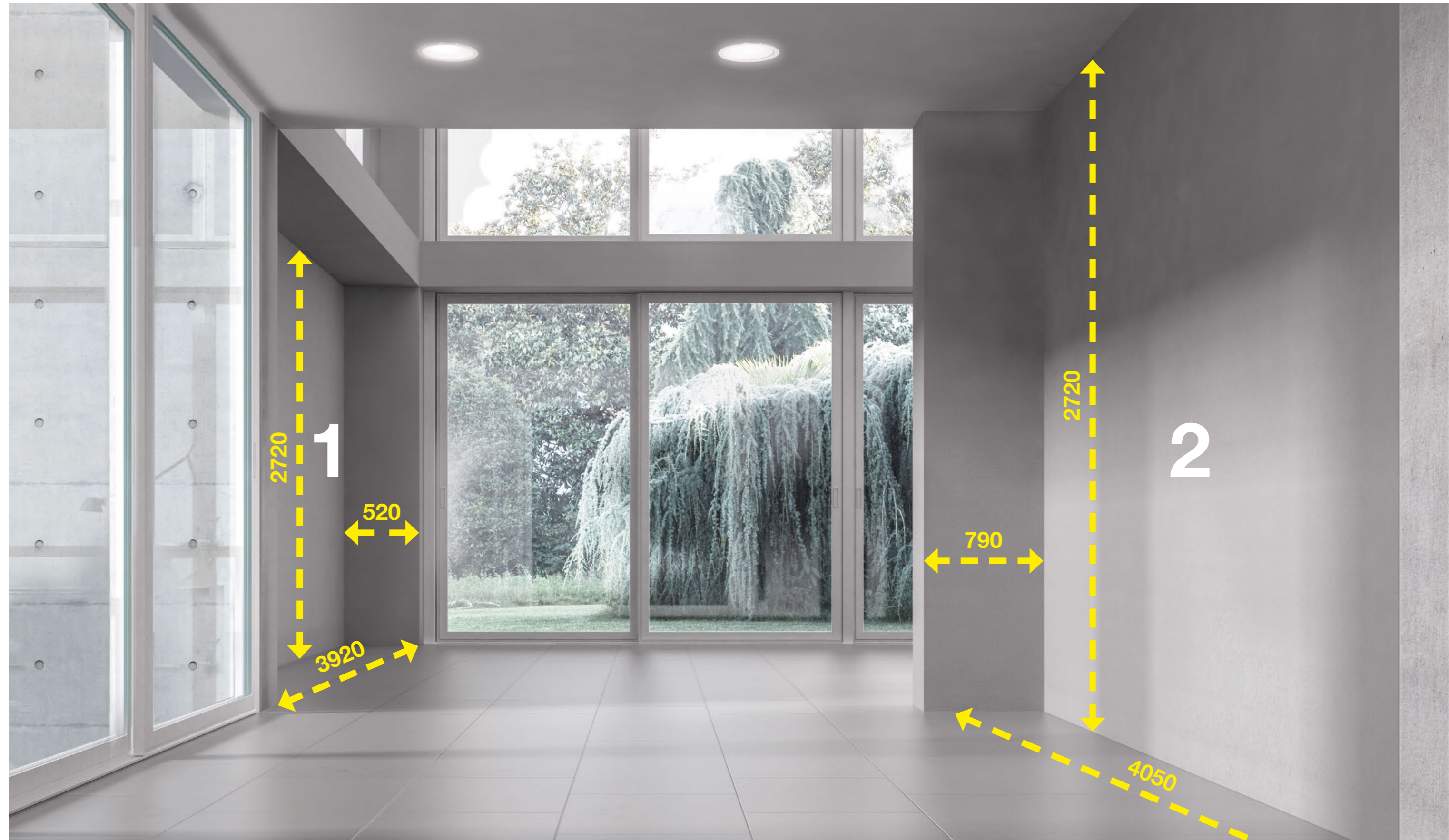
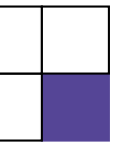

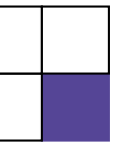

OFFICE

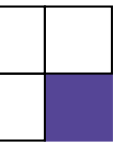

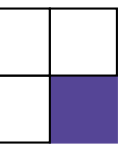

■ Maniglia M8 - M8 Handle - Poignée M8



BATHROOM

# FREESTYLE MIX



■ Il sistema misto *FREESTYLE MIX*, che combina anta battente ed anta scorrevole, permette di sfruttare al meglio tutte le potenzialità di entrambe le soluzioni. Il vano chiuso dall'anta scorrevole, non avendo il basamento, consente l'inserimento della lavatrice o di elementi su ruote.

The mixed system *FREESTYLE MIX*, which combines hinged and sliding doors, allows you to take full advantage of both solutions. The compartment closed by the sliding door, without the base, allows for the inclusion of the washing machine or of units on wheels.

Le système mixte *FREESTYLE MIX*, qui associe porte battante et porte coulissante, permet d'exploiter au mieux toutes les potentialités des deux solutions. Le compartiment fermé par la porte coulissante, sans base, permet l'insertion de la machine à laver ou d'éléments sur roulettes.



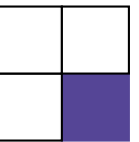

## MULTIBOX



■ Il sistema *MULTIBOX* è estremamente flessibile e, grazie all'ampia modularità, consente la realizzazione di infinite soluzioni di contenimento per ogni angolo della casa. Disponibili nelle versioni pensili, su ruote, o basi e in molteplici varianti di aperture.

The *MULTIBOX* system is extremely flexible and, thanks to its modularity, allows for the creation of an infinite number of storage solutions for each and every corner of the house. Available in hanging units, on wheels, or bases, and with a wide range of openings.

Le système *MULTIBOX* est extrêmement flexible et, grâce à une grande modularité, il permet la réalisation de solutions de rangement infinies pour le moindre coin de la maison. Disponibles dans les versions suspendues, sur roulettes, ou bases et en de multiples ouvertures différentes.



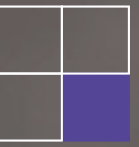

■ Il sistema ad ante scorrevoli *FREESTYLE S* esalta al massimo la semplicità del design. Come per il sistema ad ante battenti, non sussistono limiti nell'utilizzo delle finiture, caratteristica che rende personalizzabile l'armadio e tutti i suoi accessori interni. Le ante, dotate di tiranti regolabili, sono disponibili unicamente in melamina e possono essere realizzate con maniglia **M1**, ricavata nello spessore dell'anta o con maniglia **M8**, un profilo in alluminio che si estende su tutta l'altezza.

The sliding door system, *FREESTYLE S*, truly enhances simplicity of design. Just like for the system with hinged doors, there are no limits in the use of finishes – a feature that makes the wardrobe and all its internal accessories customizable. The doors, equipped with adjustable tie rods, are available only in melamine and can be equipped with the **M1** handle, cut out from the thickness of the door, or the **M8** handle, with aluminium profile, which extends along the height of the door.

Le système à portes coulissantes *FREESTYLE S* exalte au maximum la simplicité du design. Comme pour le système à portes à battant, il n'existe pas de limites dans l'utilisation des finitions, caractéristique qui rend l'armoire personnalisable ainsi que tous ses accessoires internes. Les portes, dotées de tirants réglables, sont disponibles uniquement en mélamine et peuvent être réalisées avec poignée M1, obtenue dans l'épaisseur de la porte ou avec poignée M8, un profilé d'aluminium qui s'étend sur toute la hauteur.



Progetto grafico: Studio Methodus, Giussano (MB)  
Fotografie: Master fotografie - Studio Eleven  
Styling: Paola Citterio  
Fotolito: CD cromo  
Stampa: Arti Grafiche Corbella

erbamobili.com



**ERBA**

Via don Guanella, 28 - c. p. 119  
22066 Mariano Comense (Como) Italy  
Tel: +39 031 746 663 - Fax: +39 031 750 624  
[www.erbamobili.com](http://www.erbamobili.com) - [erba@erbamobili.it](mailto:erba@erbamobili.it)  
[www.tommiejerry.com](http://www.tommiejerry.com) - [www.iq-systembeds.com](http://www.iq-systembeds.com)